

HOW TO USE YOUR
Bell & Howell / Canon

Canonet 19

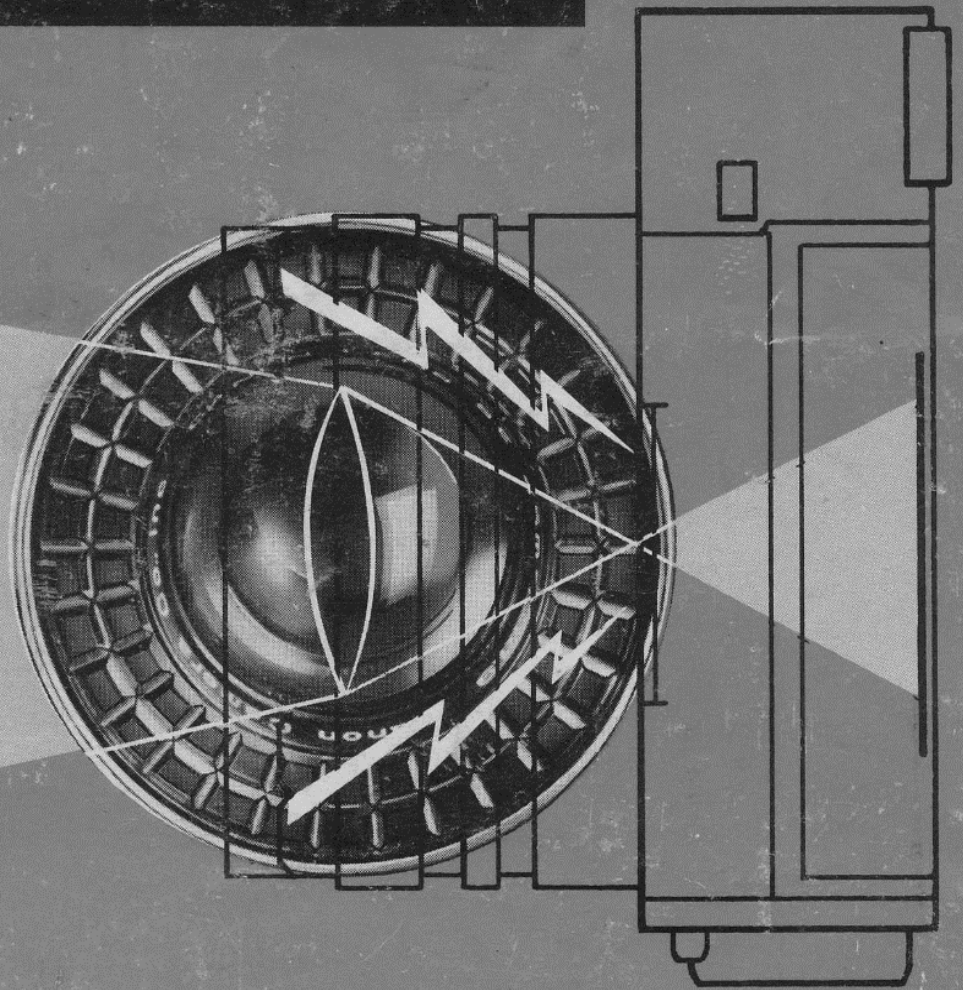

Automatic Electric Eye
35mm Camera

You'll Really Have FUN with
Electric Eye Photography!



Using the Canonet is so simple, so easy, yet you will capture your subject with such a high degree of accuracy *everytime* that taking pictures becomes really fun. Operation is so fast, so automatic that nothing need be missed even under difficult lighting conditions. Photo problems vanish, and hours of fun, enjoyment and entertainment lie ahead — for yours is the world's finest amateur 35 mm camera — built to last you a lifetime.

FEATURES OF THE

Canonet 19

- **Fully Automatic Exposure System.** Extremely sensitive "Around the Lens" Electric Eye assures perfect exposure control . . . won't let you take a bad picture. Shutter locks if lighting is incorrect. Completely automatic with film speeds ASA 10-200 plus manual.
- **"Data Center" Viewfinder.** Frames exact picture area . . . shows you the lens setting . . . warns you of improper lighting . . . and shows how to correct for perfect exposure. Parallax corrected.
- **Between The Lens Shutter.** Shutter speeds from 1 second to 1/500 second plus Bulb and Time Exposure. Stop motion or take beautiful night scenes. Fully synchronized for flash bulbs or electronic flash.
- **Built-In Self Timer.** Allows 10 second time to get into the picture yourself before shutter is snapped.
- **Sharp 45m f/1.9 Lens.** Color corrected semi-wide angle lens allows greater coverage and produces brilliant color or sparkling black and white pictures.
- **Convenient, Built-In Rangefinder.** Double image type rangefinder is quick and easy to use. Sets distance accurately from 3' to infinity to produce corner to corner sharpness.
- **Other Convenient—Quality Features.** Self-resetting exposure counter . . . single stroke "trigger lever" film wind . . . rapid crank system film rewind.

SHUTTER SPEED TABLE

LIGHT CONDITION (Aperture Set to AUTO)	FILM SPEEDS					
	ASA 10	ASA 16	ASA 32	ASA 50	ASA 100	ASA 200
Bright Sun Strong Shadows	1/60	1/60	1/125	1/250	1/500	1/500
Hazy Sun Weak Shadows	1/60	1/60	1/125	1/125	1/250	1/250
Cloudy Bright or Open Shade	1/30	1/30	1/60	1/60	1/60	1/60
Indoors 100 Watt Lamp	—	—	—	—	Tripod 1/8 Only	Tripod 1/15 Only

DEPTH of FIELD TABLE

Distance Scale Setting	F/STOP NUMBER						
	1.9	2.8	4	5.6	8	11	16
Infinity (∞)	8'7" to ∞	5'6" to ∞	4'4" to ∞	28'10" to ∞	20'2" to ∞	14'9" to ∞	10'2" to ∞
10 feet	8'11" to 11'4"	8'7" to 12'1"	8'1" to 13'3"	7'6" to 15'2"	6'9" to 19'7"	6'0" to 30'8"	5'1" to 11'8"
5 feet	4'9" to 5'4"	4'7" to 5'6"	4'6" to 5'8"	4'4" to 6'0"	4'1" to 6'7"	3'9" to 7'5"	3'5" to 9'8"
3 feet	2'11" to 3'1"	2'10" to 3'2"	2'9" to 3'3"	2'8" to 3'4"	2'7" to 3'6"	2'6" to 3'9"	2'4" to 4'2"

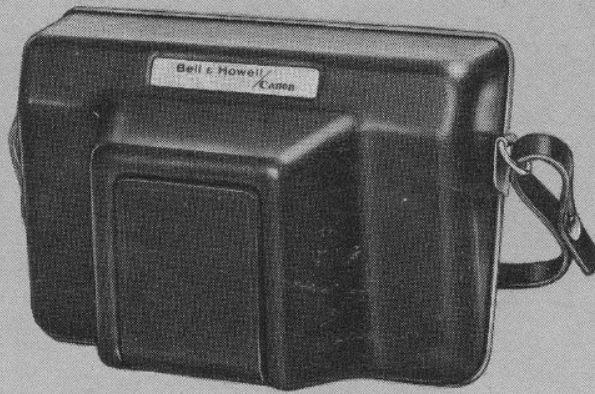

Eveready Case.

The front of the case swings out of the way for camera operation without removal, or may be removed entirely, if desired.

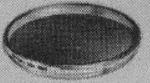

ACCESSORIES FOR THE

Canon



Gadget Bag.

The gadget bag in black full grain cowhide, crafted by Bell & Howell, is ideal for conveniently carrying camera accessories and extra film.

Cable Release.

Sturdy, all-metal release cable is available with screw down lock for time exposure control.

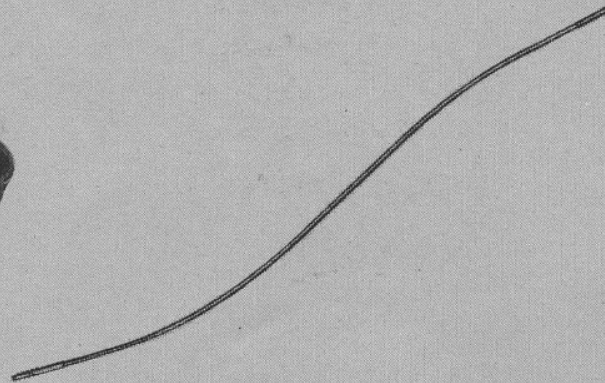

Screw-in Type Filters.

An assortment of filters for color and black and white film are available. These 55 mm filters screw into the lens rim. Exposure compensation is automatic, as they cover the electric-eye photo-cell as well as the lens. Available types for color film are: 1A, 80C, 80B, 81A, 82A, 85B, 85C. Available types for black and white film are: UV, Y1, Y3, O1, R1 and G1 in plastic case.

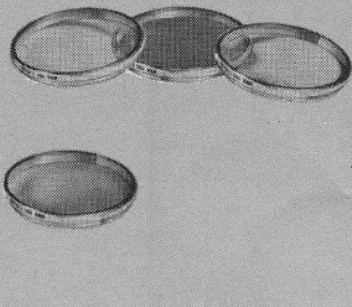

Flash Unit.

The flash unit is convenient and compact with folding-type reflector. It attaches to the accessory clip and locks in place. Case included.

Clamp-on Type Lens Hood.

A lens hood is always desirable to eliminate reflections and other light outside the photographic range of the subject. The lens hood clamps on with a single thumb-screw. It is self storing, and may be put on in reverse position for carrying when not in use.



WELCOME
TO
BELL & HOWELL
OWNERSHIP

The name Bell & Howell/Canon combines the best American and Japanese imagination with engineering and painstaking craftsmanship, famous the world over. No expense has been spared, no detail considered too minor for the loving attention of these camera specialists in meeting the challenge of this original design. With the Canonet 1⁹ we are proud to welcome you to Bell & Howell ownership.

THE BELL & HOWELL COMPANY

Bell & Howell

G U A R A N T E E

This new Bell & Howell product is guaranteed to be free from imperfections in both material and workmanship for one year from date of original purchase. Should any part of this equipment be defective, it will be replaced or repaired free of charge (except for transportation), providing the equipment has been operated according to the instructions accompanying it.

No liability is assumed for film which is damaged or is unsatisfactory for any reason and no liability is assumed for interruptions in operation of equipment. This guarantee is void:

- a) If equipment has been damaged by accident or mishandling;
- b) If equipment has been serviced by other than Bell & Howell approved service stations*;
- c) If adaptations or accessories other than Bell & Howell have been made or attached.

The foregoing is in lieu of all other warranties expressed or implied and Bell & Howell Company neither assumes nor authorizes any person to assume for it any other obligation or liability in connection with this product.

**Location of nearest approved service station will be furnished on request.*

Once you have used your camera, tell us if you are satisfied with your purchase. Please fill out the enclosed Owner Purchase Form. Your camera Serial Number is located on the inside instruction plate.

Bell & Howell

7100 McCormick Road
Chicago 45, Illinois

BE USED FOR SPECIAL PHOTOGRAPHIC EFFECTS. TO DO THIS, SIMPLY TURN THE

ROTATE SAFETY LEVER

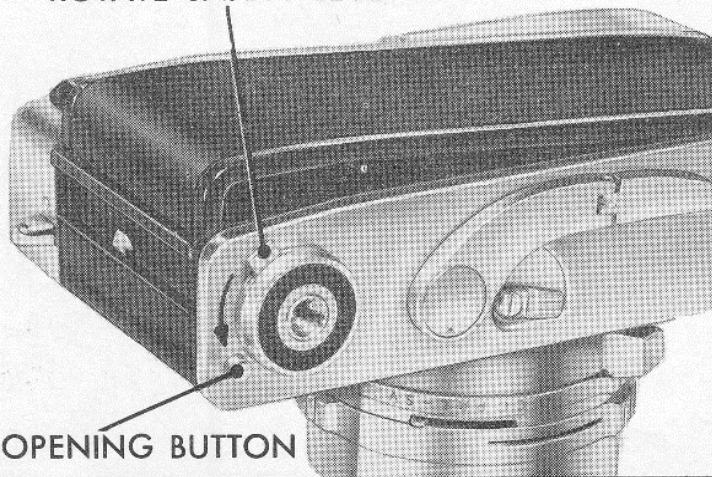

PUSH OPENING BUTTON

HOOK

FILM SLOT

TAKE-UP SPOOL

KNURLED FLANGE

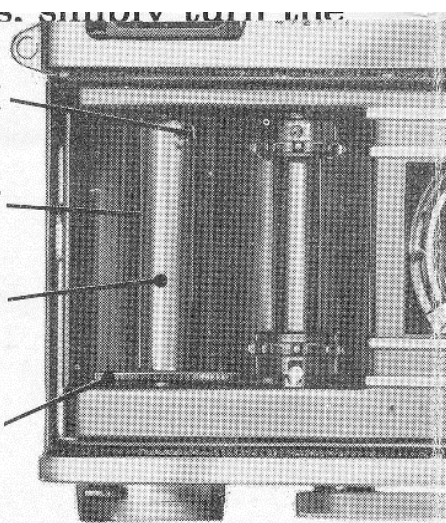

LOADING FILM

(Use standard daylight loading 35 mm film cassettes. Load the film as follows:)

1. Open the camera back by moving the back-cover safety lever counterclockwise as far as it will go and then pressing the back-cover opening button. The back cover will spring open.

2. Rotate the takeup spool by means of the knurled flange at the bottom until the film slot is at the outside of the spool and the hook, which engages the film perforation, is at the top.

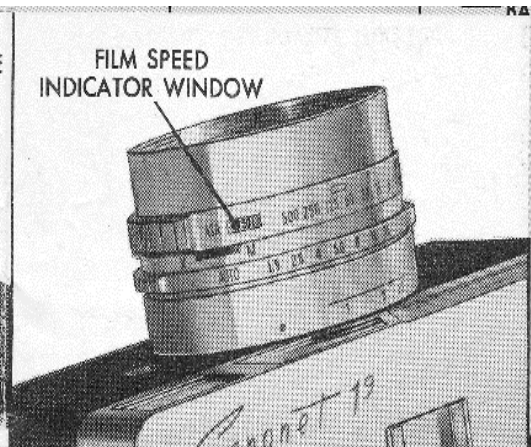
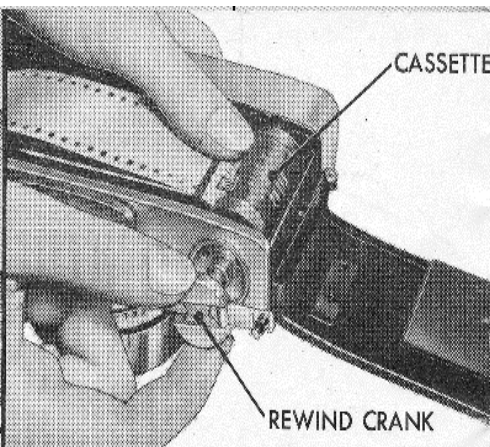
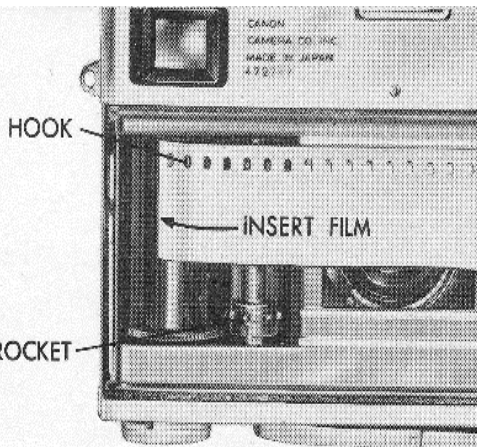

3. Insert the end of the film into the loading slot of the takeup spool. See that the hook engages one of the sprocket holes, as shown. Then rotate the spool to see that the film is securely attached.

4. Pull the rewind crank out all the way and insert the cassette. Push the rewind crank back. See that the teeth of the sprocket accurately engage the perforations before closing the back cover.

5. Set ASA film speed number of the film into the film speed indicator window by moving the film speed indicator lever. If the film speed desired is between the numbers in the window, set between numbers.

6. Move the aperture ring from AUTO to some number on the scale. Press the shutter release button. Wind the film and press the shutter release button and again wind the film and press the release button. The exposure counter dial will now have advanced to 0 and your camera is ready for use. (The exposure counter dial automatically resets when the back cover is opened.) Reset the aperture ring to AUTO.

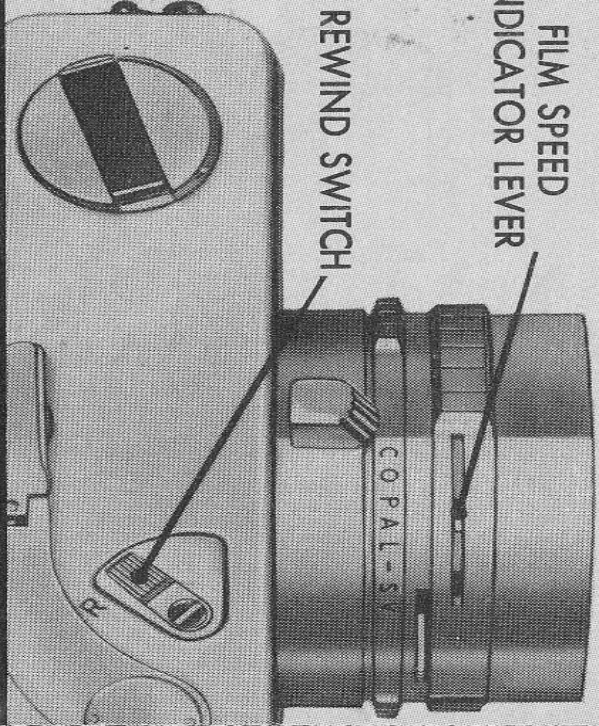

FILM SPEED INDICATOR LEVER

REWIND SWITCH

UNLOADING EXPOSED FILM

When you reach the end of the film you will feel a resistance in advancing the film. Do not force the film advance lever, but unload the film as follows:

1. Move the rewind switch to R, as shown.

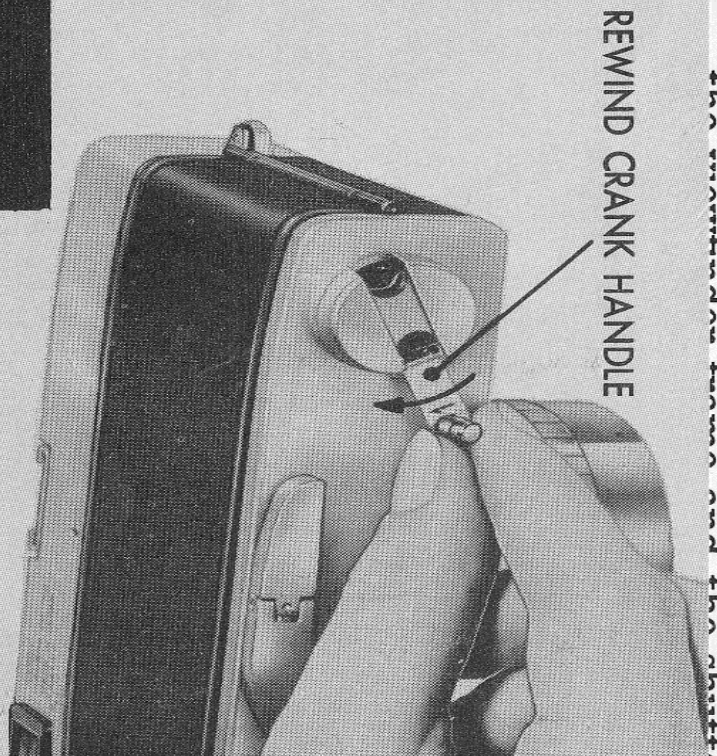

REWIND CRANK HANDLE

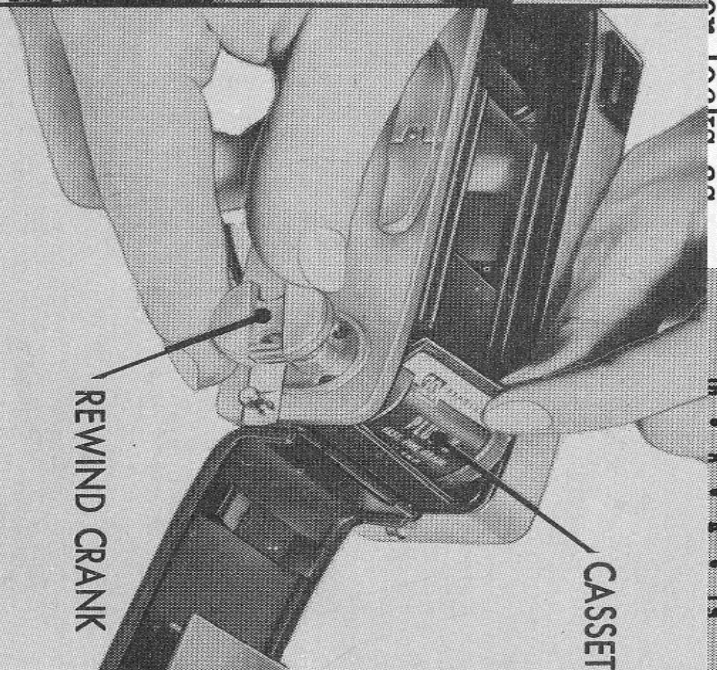

CASSET

REWIND CRANK

FILM

2. Raise the rewind crank handle to operating position and turn it clockwise to rewind the film into the cassette. Stop winding when the tension on the crank suddenly ceases.

3. Open the back cover and pull the rewind crank out all the way. Remove the cassette.

(The rewind switch will return to its original position when the film advance lever is moved.)

operation step 6, above. This trips the shutter to take the picture.



Set Lens Opening and Shutter Speed for Manual Operation

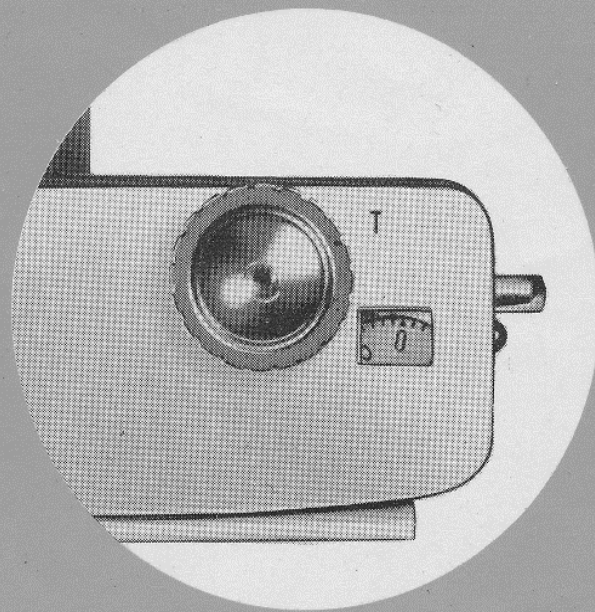

Set Time Ring for Time Exposures



Canonet with Flash Unit in Place

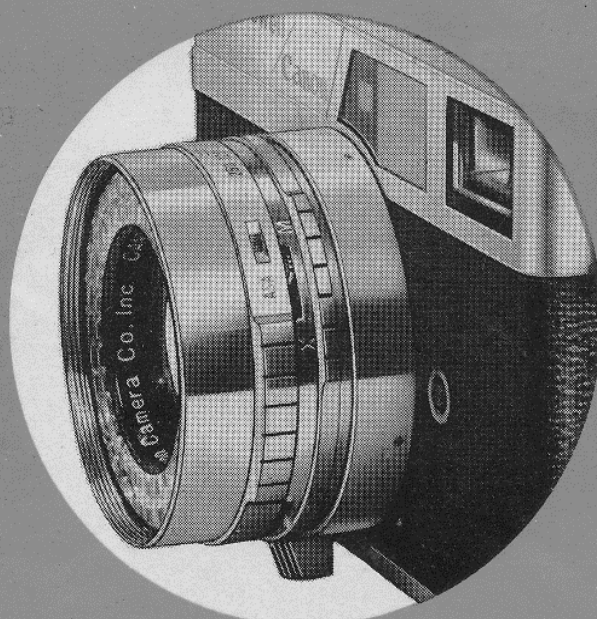

Set Flash-Setting Lever for Type of Bulb

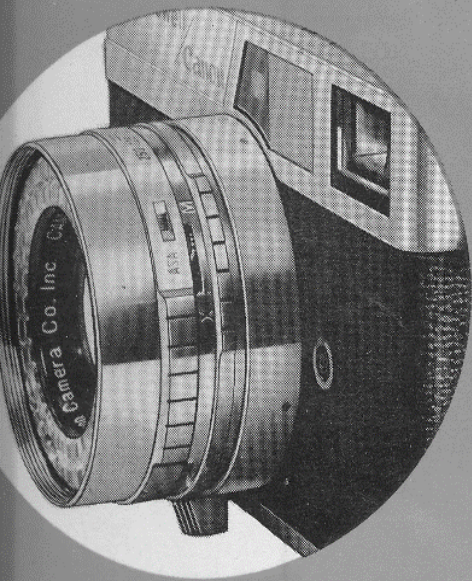

FLASH BULB	SETTING	SHUTTER SPEED
"M" type	"M"	All shutter speeds.
"F" type	"X"	Slower than 1/60 sec.
Speedlight	"X"	All shutter speeds.

Set Flash-Setting Lever
for Type of Bulb

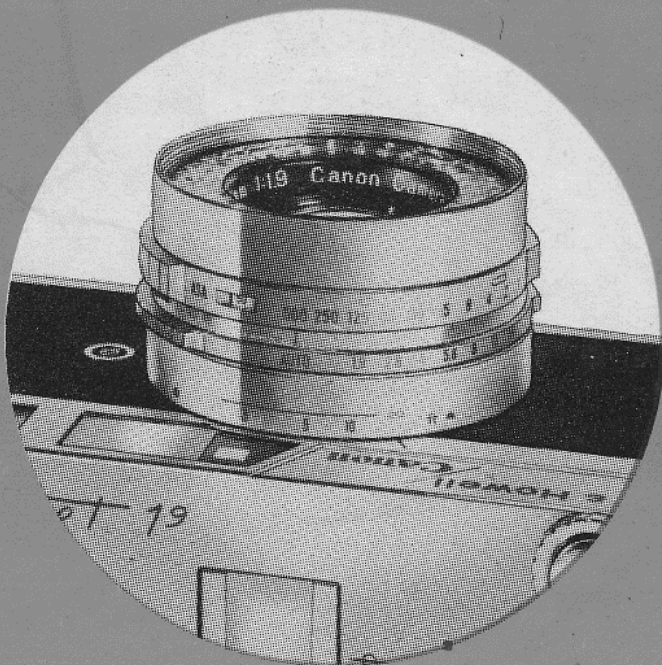

Distance Scale is Useful
for Flash Exposures

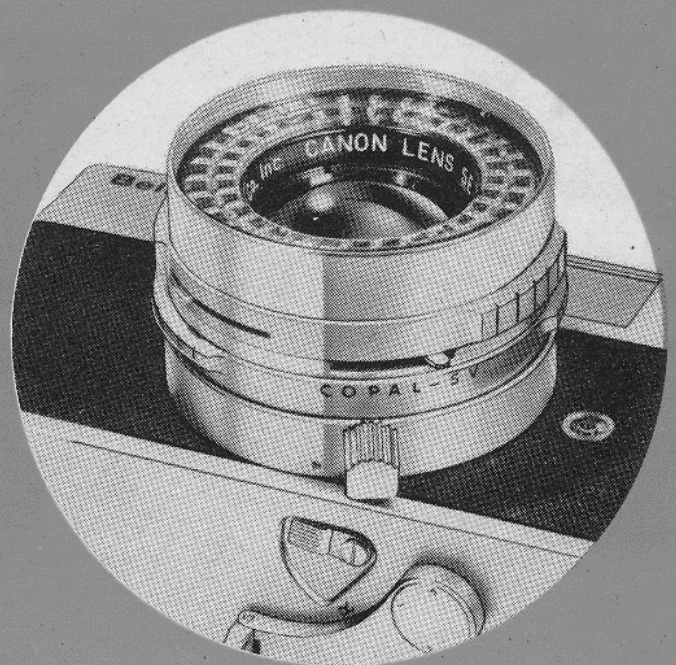

Push Self Timer Lever Down
for Time-Delayed Exposures

Preparation for Automatic Electric-Eye Operation

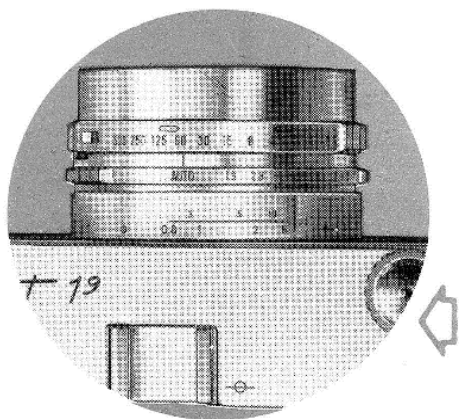

- **Load the Film.**

It's easy, follow the steps on the flap below. Be sure to set the film speed indicator to the correct speed of the film you load into your camera.

- **Set for Automatic Operation.**

Move the aperture ring to AUTO position.

- **Set the Shutter.**

Turn the shutter-speed ring to line up the correct shutter speed with the index mark. Always set the shutter-speed ring so that one of the numbers lines up with the index mark. *Never* set between numbers. Shutter speed should be fast enough to stop any motion of the subject, but slow enough to get the required depth of field. See the Shutter Speed and Depth of Field Tables on the back of this sheet.

(When turning the aperture ring or the shutter-speed ring, grip it by the raised finger-grips on either side, using care not to move the film-speed lever.)

Never set the shutter-speed ring to B for automatic electric-eye operation. If this is done by mistake, the shutter will lock. Correct as follows:

1. Turn the aperture ring from AUTO to some number on the aperture scale (1.9, 2.8, etc.)
2. Press the shutter-release button.
3. Turn the shutter-speed ring from B to some number on the shutter-speed scale. (15, 30, 60, etc.)
4. Reset the aperture ring to AUTO to return to automatic operation.

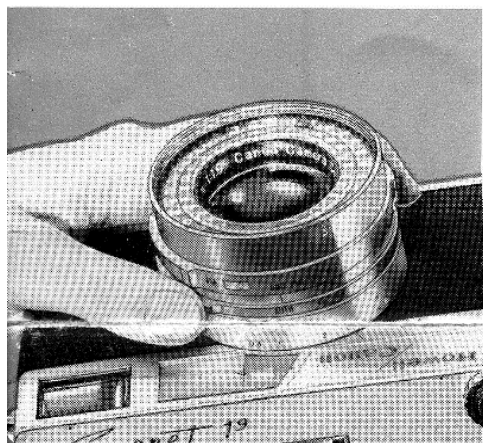

Manual Exposure Setting and Flash Operation

When there is not enough light for automatic operation, the use of flash bulbs is recommended. The manual exposure setting can also be used for special photographic effects. To do this, simply turn the aperture ring from the AUTO position to some other position on the lens-aperture ring. Then —

- 1. Set the Lens Opening.** Move the aperture ring to the F stop for the required exposure, as shown below, left.
- 2. Set the Shutter Speed.** Turn the shutter speed ring to the correct shutter speed for the required exposure, as shown below.
- 3. Wind the Film and Cock the Shutter.** Swing the film advance lever toward you until it stops, just as in automatic operation step 1, above. This winds the film, cocks the shutter and advances the exposure counter dial.
- 4. Compose Your Picture and Focus.** This is done exactly as for automatic operation step 2, above.
- 5. Take the Picture.** Press the shutter release button as for automatic operation step 3, above. This trips the shutter to take the picture.

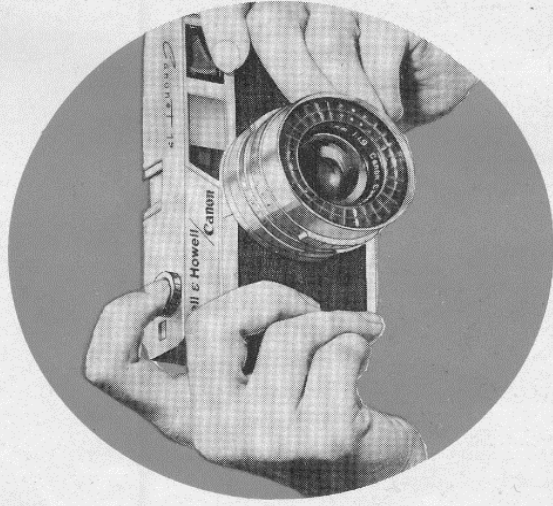
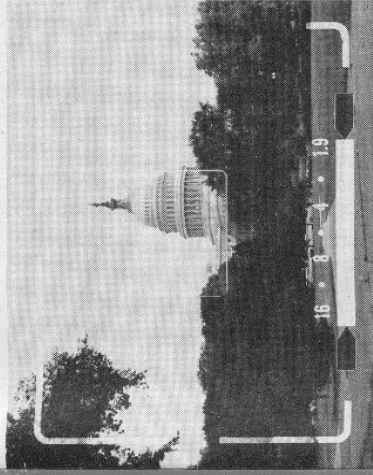
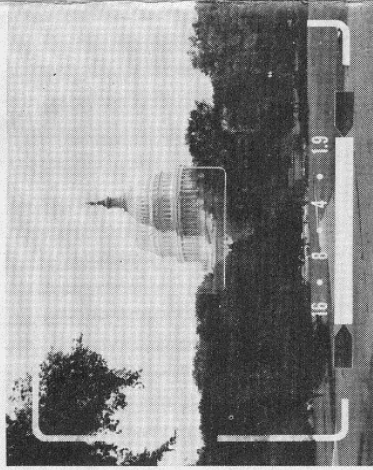
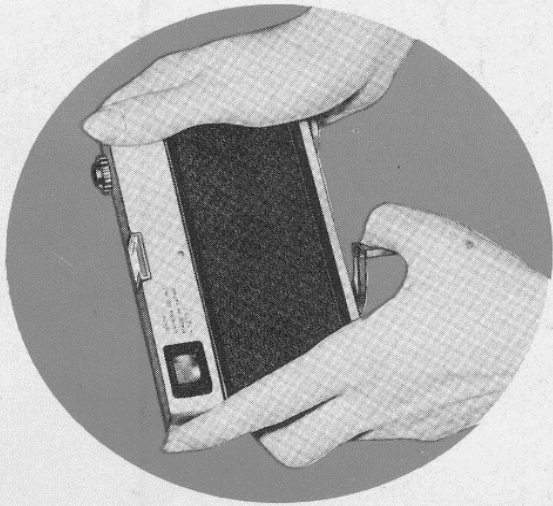

Taking the picture . . . as simple as 1, 2, 3

- 1. Wind the Film and Cock the Shutter.** Swing the film advance lever toward you until it stops. This winds the film, cocks the shutter and advances the exposure counter dial to show the number of the picture you are now ready to take.
- 2. Compose Your Picture and Focus.** Look at your subject through the rangefinder-viewfinder eyepiece. Compose your picture within the white frame of the viewfinder. This is the picture area which will be recorded on film. Move the focusing lever and you will see

two images moving together or separating within the comparatively bright rectangle at the center of the picture area. Move the focusing lever until the two images match perfectly and only one image can be seen. This area of your subject is then exactly in focus.

- 3. Take The Picture.** Press the shutter-release button *gently*, to avoid moving the camera. *Be sure you understand how the shutter-release button and viewfinder data center operate, as shown at right.*

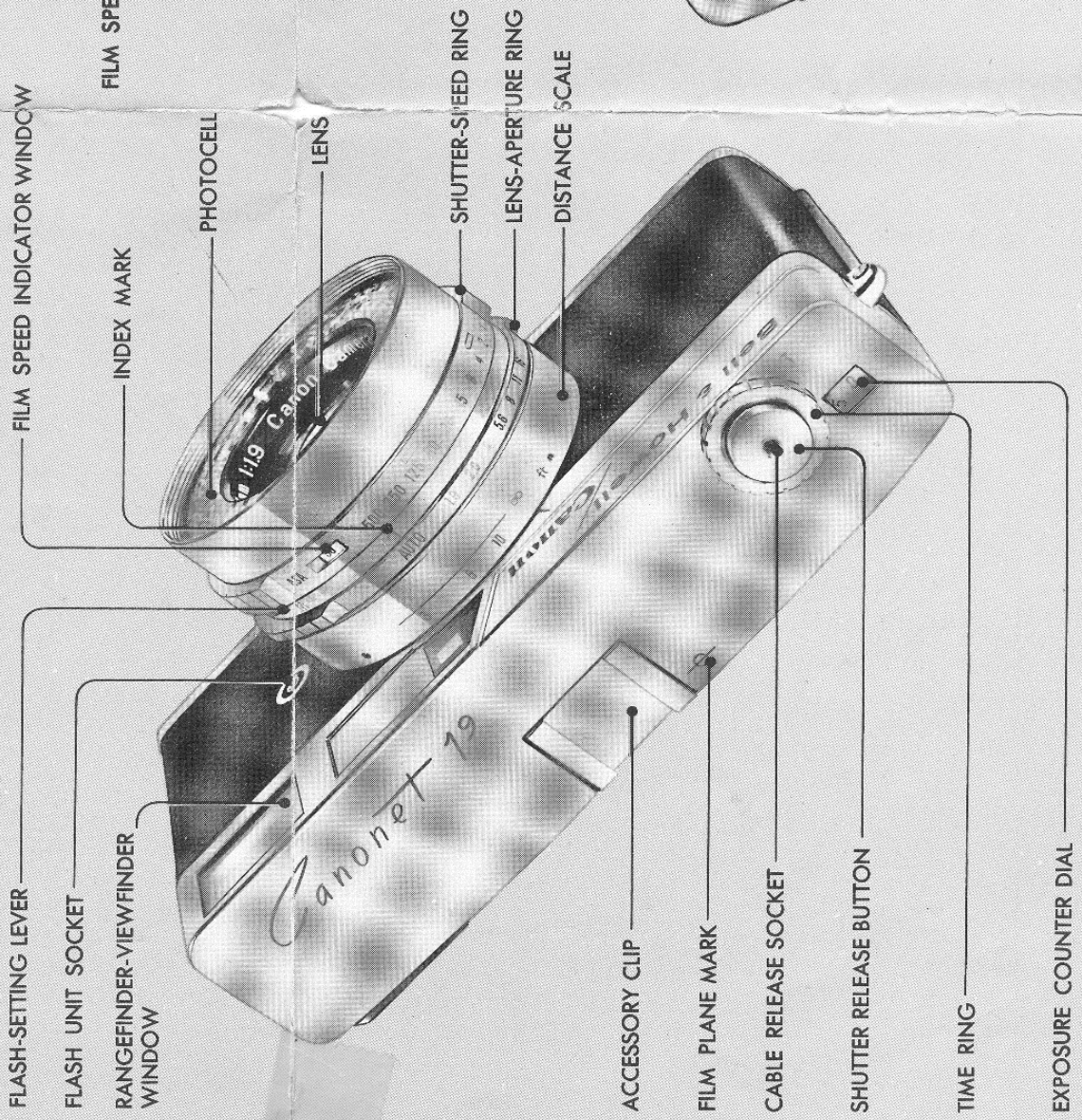
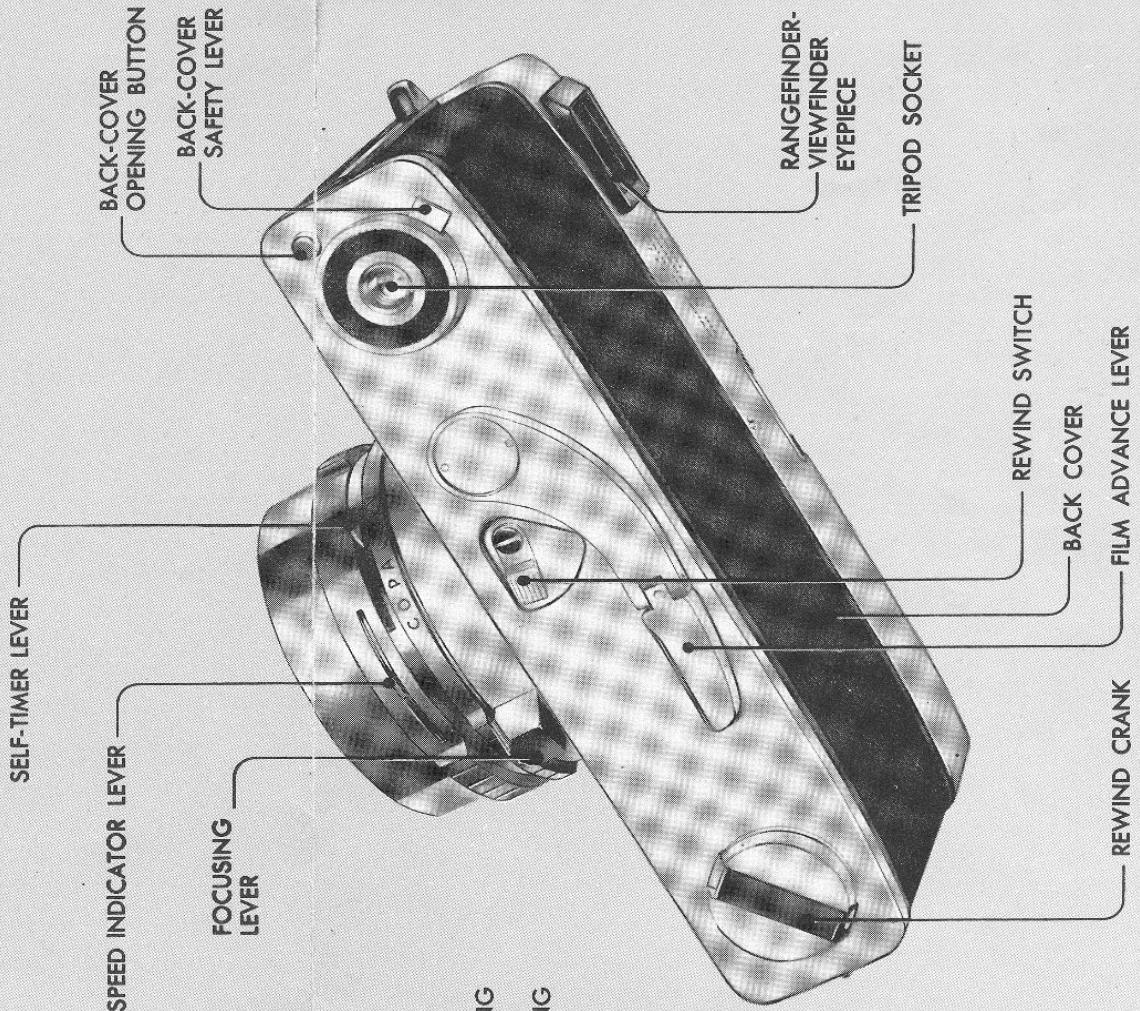

Bulb Exposures

Set the shutter-speed ring at B and then wind the film and cock the shutter. Press down on the shutter-release button to open the shutter. Hold it down for the required exposure time. Release to close the shutter and complete the exposure. Use this setting with a tripod or other firm support for exposures of more than 1 second. Use of a cable release with B exposures will prevent camera movement and assure better pictures.

Time Exposures

Set the shutter speed ring to B and turn the time ring counter-clockwise to set the dot on the time ring to the letter T as shown below, left. Then wind the film and cock the shutter. Press the shutter-release button all the way down. It will lock it in this position with the shutter open. When the exposure time has elapsed turn the time ring clockwise to move the dot away from the T. This will release the button and close the shutter. A tripod should always be used in making time exposures.

Flash Exposures

The accessory flash unit is designed for the use of either all glass (AG) or European style Phillips base (PH) bulbs. (It will not accept M2 or M5 bulbs). Move the small button on the bottom of the unit to shift the socket to the "AG" position. Then attach the flash unit to the accessory clip on top of the camera by sliding it into the clip as shown below, left. Swing the leadwire behind the flash unit, so that it can not get in front of the lens, and insert the tip of the connecting leadwire into the flash-unit socket.

A convenient exposure scale for determining the correct flash exposure is found on the top of the flash-unit, as shown below. To use the scale, rotate the disc until the indicator mark for the bulb being used (clear or blue) lines up with the film speed (ASA number) of the film in the camera. Then read off the correct aperture F number from the disc opposite the distance in feet to your subject. Take the picture by following the five steps of MANUAL OPERATION.

M and F type flash bulbs or a speed light can be synchronized from the flash-unit socket but it is necessary to set the flash-setting lever for the type of bulb being used. Set according to the table below.

Shutter-Release Button Operation

The shutter-release button operates in two stages for automatic operation. As it moves downward on its first stage, it sets the electric-eye mechanism for correct exposure at the shutter speed previously set with the shutter-speed ring. As it does this you can see the black needle move across the indicator scale in the viewfinder to show you the aperture at which the picture will be taken. As the button moves all the way down in the second stage, it releases the shutter to record the picture on the film.

NOTE

If the shutter release button locks after the first stage and will not move down to release the shutter, this is your warning that correct exposure cannot be made at this shutter setting or with existing light. See "Viewfinder Data Center" below.

Viewfinder Data Center

The data center in the viewfinder shows you everything you need to take perfect pictures. It is visible through the eyepiece at the lower edge of the picture composition frame. The red arrows on the left and right are shutter speed-change marks. The numbers across the center are lens-aperture scale (F/stop) numbers.

Normal Operation.

As the shutter-release button is pressed through its first stage, the black needle moves from the extreme right to the left until it indicates the aperture at which the picture is being taken.

Shutter Speed Too Fast.

If the black needle remains within the right hand shutter speed-change arrow the shutter will lock as the shutter-release button is pressed through its first stage. This is your warning that there is not enough light for proper exposure at the shutter speed set on the shutter-speed ring. The red speed-change arrow points to the left, so turn the shutter-speed ring to the left to select a slower shutter speed. Then take the picture in the usual manner.

Shutter Speed Too Slow.

If the black needle moves all the way into the left hand shutter-speed change arrow the shutter will lock as the shutter-release button is pressed through its first stage. This is your warning that there is too much light for proper exposure at the shutter speed set on the shutter-speed ring. The red speed-change arrow points to the right, so turn the shutter-speed ring to the right to select a faster shutter speed. Then take the picture in the normal manner.

Electric-Eye Mechanism Not Operating.

If there is so much light or so little light that the amount of light is outside the operating range of the film in the camera the black needle will move to the left to some position on the scale, but a red warning appears within the viewfinder frame and the shutter locks as the shutter-release button is pressed through its first stage. Automatic operation is not possible under these conditions. When this happens, use a time exposure or flash.

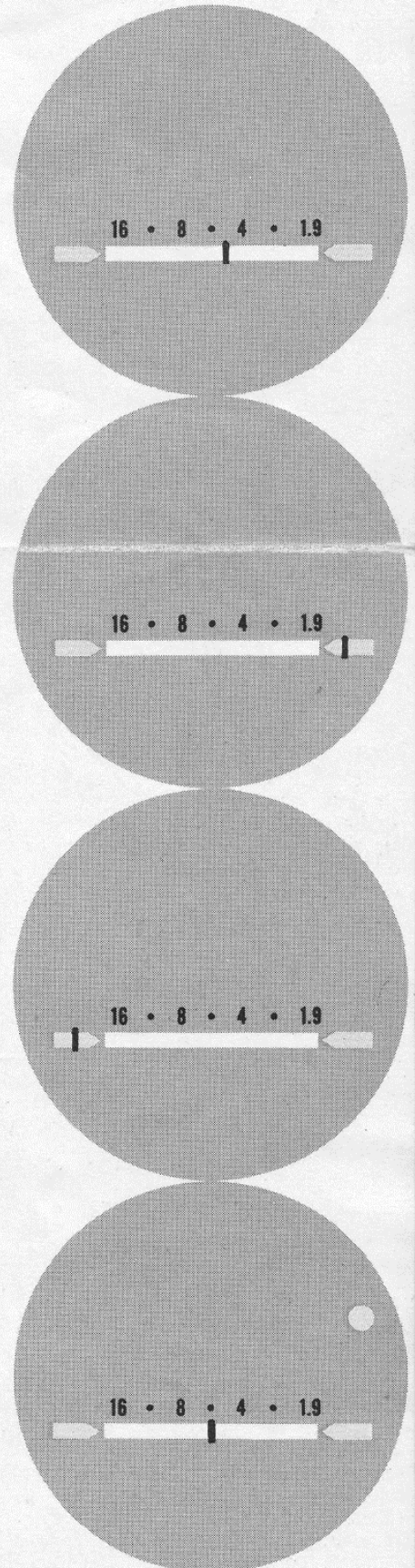

Time-Delay Exposures

The self timer can be used with automatic electric-eye operation or manual exposure-setting and electronic flash operation to provide a time-delay shutter release of about 10 seconds. Put the camera on a tripod to enable you to get into the picture yourself, if you choose. Use the self timer as follows:

- Prepare for Automatic Operation or set the lens opening and shutter speed for Manual or Flash Operation.
- Set the flash-setting lever to X.
- Wind the film and cock the shutter with the film advance lever.
- Push the self timer lever all the way down (below, right).
- Turn the time ring so that the dot is at the T.
- Press the shutter-release button. After a delay of about 10 seconds the shutter will release to take the picture.
- Move the time ring clockwise away from the T.

Important: Always set the flash-setting lever to X before moving the self timer lever. In automatic operation, incorrect exposure will result if the time ring is not set to T or if your shadow is on the photocell when the shutter release button is pressed. M type flash bulbs can not be used with the self timer.